

TOP VIEW

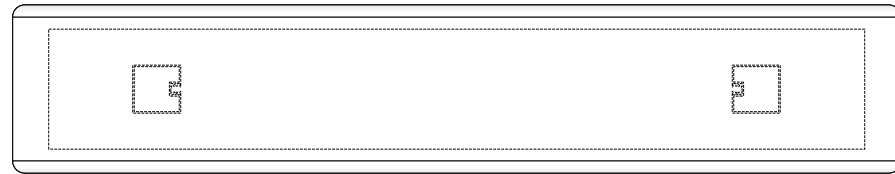

HED P-20 Detail

Removable .100" Aluminum Top Panel fastens to P-20 Extrusion with countersunk screws

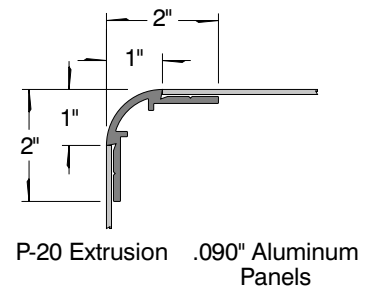
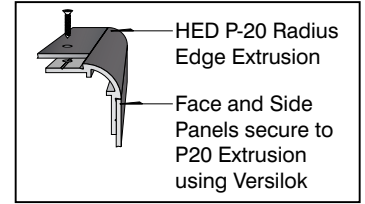
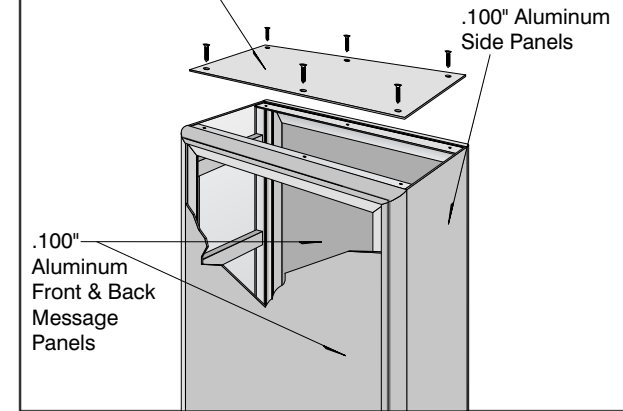

SIDE A

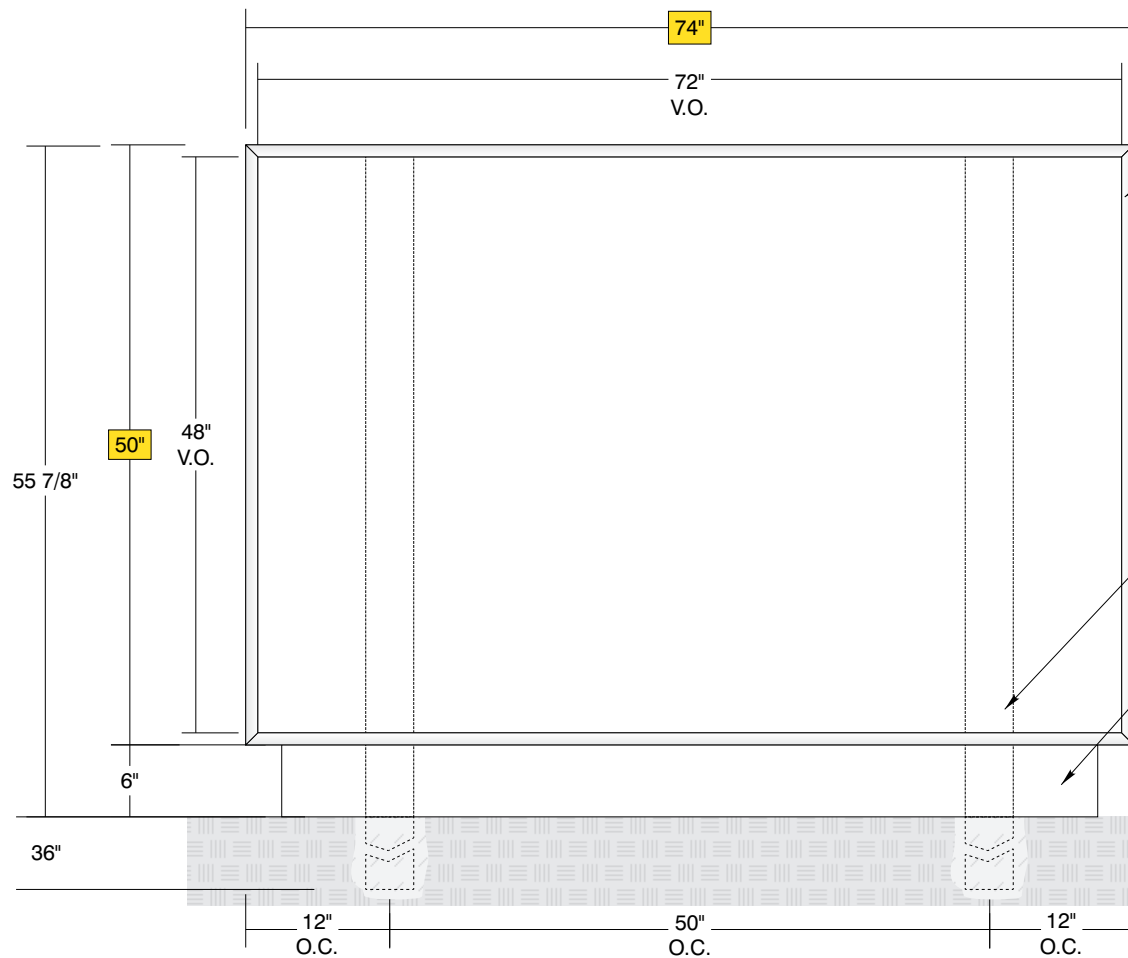

• Sign System: P-20SR Pylon

- (2) .100" Aluminum Face Panels: (H) 48" x (L) 72"
- (2) .100" Aluminum Side Panels: (H) 49.9" x (L) 12"
- (1) .100" Aluminum Top Panel: (H) 12" x (L) 74"
- (1) .100" Aluminum Bottom Panel: (H) 12" x (L) 73.8"

• Paint:

- Standard White - Frame, Panels, Base Skirt

• Double Internal Post Mount

- (2) Posts Size: 4" x 4" x (L) 91 7/8"

• Removable Base Skirt

- .080" Aluminum (H) 6" x (L) 68" x (D) 10"

SIDE VIEW

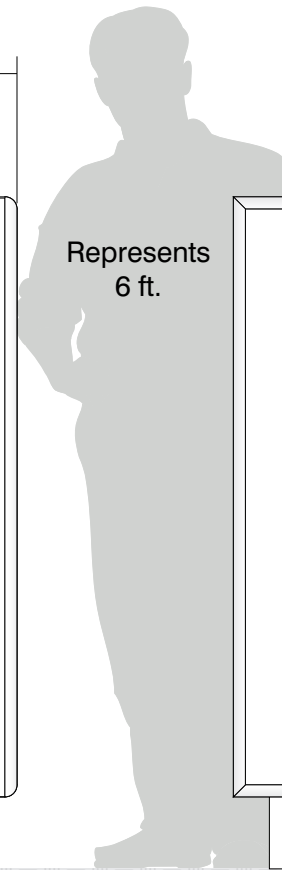
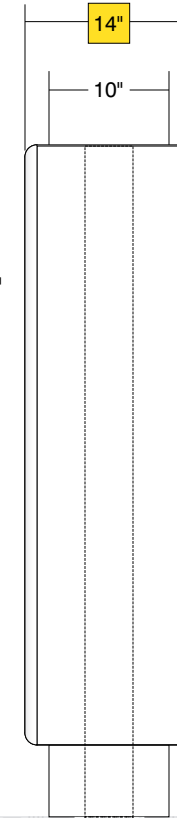

SIDE B

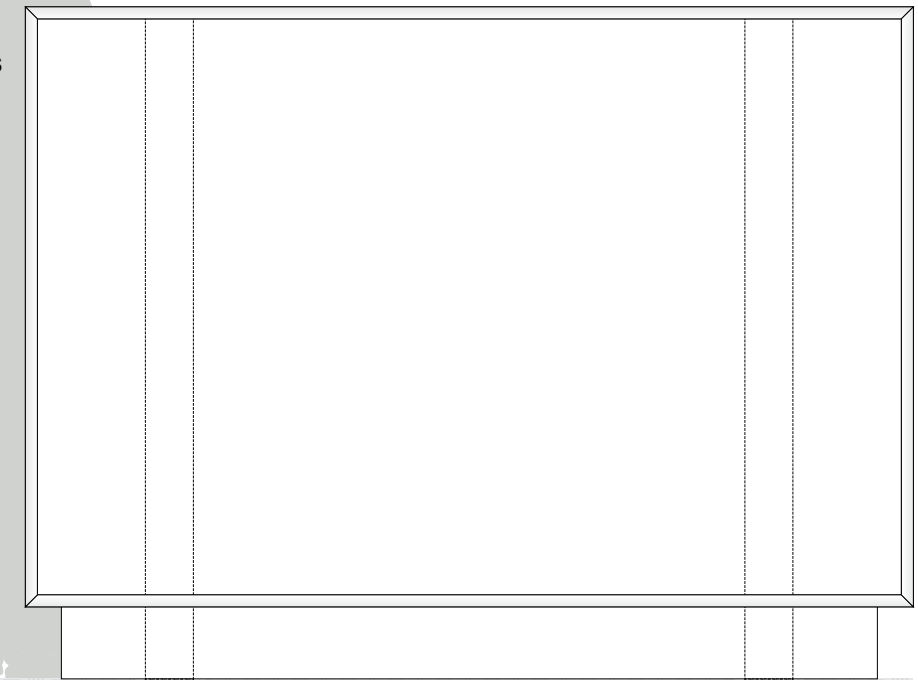

Date	DWG# HED_P-20	Scale:	3/4"=1'	Customer	Mounting	Double Internal Post Mount		Quote #	
XX.XX.XX					SF/DF	Double Face		Sales Rep.	
Quantity				Location	Illuminated	NO	UL	Illustrator:	
1					Voltage	N/A	Amp		
Page				System	ADA	No	Rev. 0	Reviewed By:	
1 of 1				HED P-20 (48" x 72") Pylon Sign System	*Due to the ADA/ANSI's wide interpretation and other factors that may exist, we cannot affirm compliance in all situations and is hereby removed from responsibility regarding these issues.				



• 6400 Howard Drive, Fairview PA 16415 • Toll Free 800.458.0591 •
 • PA 814.833.7000 • Fax 814.838.0011 •
 www.howardindustries.com

All concepts and designs represented by this drawing are the property of Howard Industries and may not be reproduced or used in any manner without written consent. ©Copyright 2020 Howard Industries.