

# HED I-70

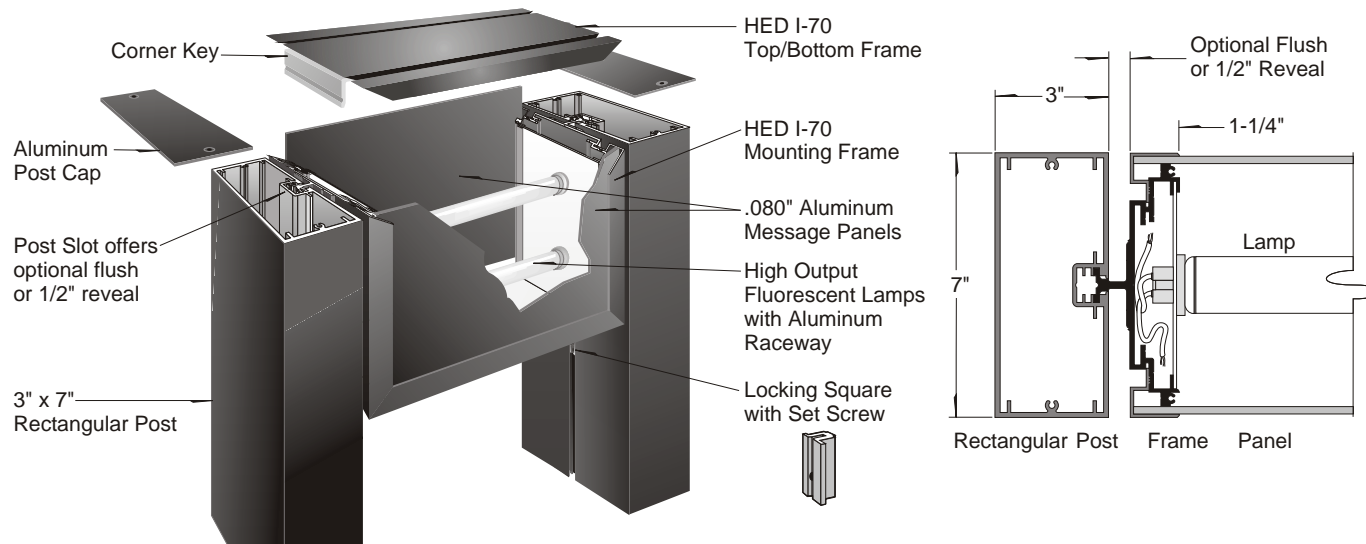

technical information